

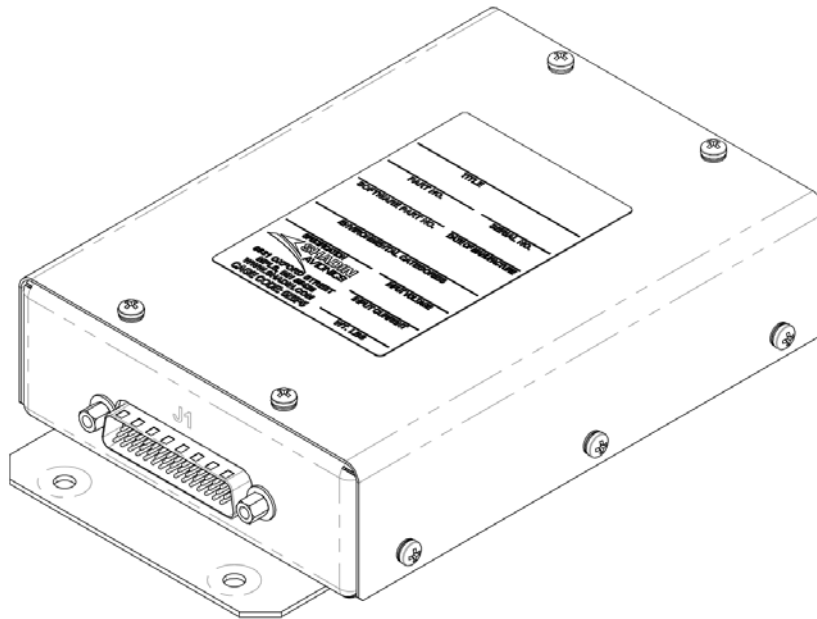

AIS-380 DC Fuel Flow Adapter

P/N: 833811-30



INSTALLATION MANUAL MANUAL P/N: M833811-30 REV B

SHADIN AVIONICS
6831 Oxford Street
St. Louis Park, MN 55426

Sales: (800) 328-0584
Customer Service: (800) 388-2849
www.shadin.com

DOCUMENT	AIS-380 DC FUEL FLOW ADAPTER	
Control SC1	INSTALLATION MANUAL	
Revision B	M833811-30	Page: 2 of 31

REVISION LOG

Rev	Date	ERN	DESCRIPTION
-	16 APR 2018	1804/003	Initial Release
A	24 JUL 2018	1807/012	Corrected DO-160F as baseline testing
B	16 OCT 2018	1810/005	Corrected typo bit 29 on page 7



DOCUMENT	AIS-380 DC FUEL FLOW ADAPTER	
Control SC1	INSTALLATION MANUAL	
Revision B	M833811-30	Page: 3 of 31

TABLE OF CONTENTS

1 OVERVIEW	4
1.1 SCOPE	4
1.2 PRODUCT DESCRIPTION	4
2 SPECIFICATIONS.....	6
2.1 PHYSICAL	6
2.2 ELECTRICAL.....	6
2.3 ENVIRONMENTAL	6
2.4 FUNCTIONAL	6
2.4.1 INPUTS	6
2.4.2 OUTPUTS.....	7
2.4.3 AIR DATA AND HEADING CONVERSION	8
2.5 SOFTWARE CERTIFICATION.....	9
2.6 REGULATORY CERTIFICATION	9
2.7 RELIABILITY.....	9
2.8 ACCURACY	9
3 INSTALLATION.....	10
3.1 LIMITATIONS	10
3.2 INCOMPLETE SYSTEM	10
3.2.1 PERFORMANCE STANDARDS.....	10
3.3 MOUNTING	10
3.4 ELECTRICAL CONNECTION	11
3.4.1 TYPICAL INSTALLATION WIRING.....	12
3.4.2 VOLTAGE TO FUEL FLOW K Factor.....	13
3.5 REPAIR	13
4 ENVIRONMENTAL QUALIFICATION FORM (EQF)	14
5 CONFIGURATION TOOL.....	15
5.1.1 CONFIGURATION TOOL SOFTWARE INSTALLATION.....	16
5.1.2 USING THE CONFIGURATION TOOL	21
APPENDIX A: INSTALLATION DRAWING	27
APPENDIX B: INSTALL KIT, PARTS LIST	30

DOCUMENT	AIS-380 DC FUEL FLOW ADAPTER	
Control SC1	INSTALLATION MANUAL	
Revision B	M833811-30	Page: 4 of 31

1 OVERVIEW

The information in this manual is subject to change without notification.

1.1 SCOPE

This manual is intended to determine a proper installation of the AIS-380 DC FUEL FLOW ADAPTER (DCFF). Installation instructions should be read and followed.

1.2 PRODUCT DESCRIPTION

The DCFF is a product designed to provide fuel flow on a digital output bus to a display or GPS receiver that can receive ARINC 429 or RS-232. The DCFF receives a DC analog signal from a fuel transducer or equivalent, ARINC 429 air data, and ARINC 429 heading. The DCFF combines this data and re-transmits on an ARINC 429 or RS-232 serial output bus.

The ARINC 429 speed, K-factor, single/twin engine selection, fuel density, and serial output formats are configurable using the PC based configuration tool referenced later in this installation manual.

DOCUMENT	AIS-380 DC FUEL FLOW ADAPTER	
Control SC1	INSTALLATION MANUAL	
Revision B	M833811-30	Page: 5 of 31

A basic overview is shown below in Figure 1.

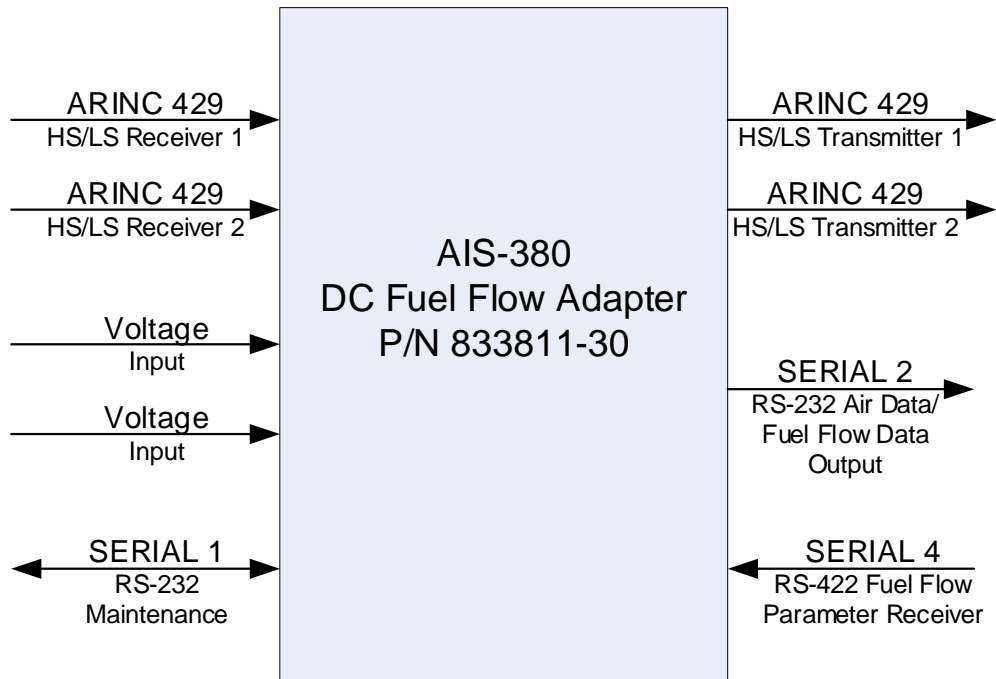



Figure 1 : AIS-380 DC Fuel Flow Adapter Overview

The features which are applicable to all standard installations are listed below:

- Two +12 VDC power supplies are available for powering fuel flow transducers
- ARINC 429 inputs are forwarded to the ARINC 429 outputs
- ARINC 429 speed (high or low) is configurable. Each ARINC 429 channel input and output speed is matched when configured, e.g. ARINC 429 channel 1 input channel set for high speed results in ARINC 429 channel 1 output set for high speed
- Fuel Flow labels 244 (Total Fuel Flow) and 347 (Left and Right Independent Fuel Flow based on SDI) are generated and output at an 8 Hz rate when configured for normal fuel flow format

DOCUMENT	AIS-380 DC FUEL FLOW ADAPTER	
Control SC1	INSTALLATION MANUAL	
Revision B	M833811-30	Page: 6 of 31

2 SPECIFICATIONS

For a complete listing of product qualifications please review the Environmental Qualification Form (EQF) found in Section 4.

2.1 PHYSICAL

Nominal Dimensions:	6.90"L x 4.24"W x 1.57"H
Weight:	0.7 pounds (lbs)
Mounting:	4 Screws (See Installation Drawing D833811-30)
Mounting Locations:	6.25"L x 2.00"W

2.2 ELECTRICAL

Power Supply Voltage:	+28VDC Nominal
Supply Current:	100mA at +28VDC
Protection:	Not internally fused

2.3 ENVIRONMENTAL

RTCA/DO-160F [A4X]BBB[R(B,B1) U2(F, F1)]EXXXXXZ[BXX]AZ[CC][RR]M[XXJ3L3]XXAX

Operating Temperature:	-40°C to +70°C
Storage Temperature:	-55°C to +85°C
Operating Altitude:	Up to 42,000 ft.

The Qualification Test Report shows the environments qualified to DO-160F by test and by similarity to tests originally performed on the baseline hardware.

Equipment can run indefinitely within stated environmental range with no external cooling.

2.4 FUNCTIONAL

2.4.1 INPUTS

The DCFF accepts the following inputs

- Two Analog signals – DC Fuel Flow
 - Accept analog inputs between -1.0 v and +30.0 volts
 - Negative voltages are recognized as 0.0 volts
 - Voltages greater than 10 volts are considered to be out of Range
 - DC Input 1 POS on DCFF pin 9 (signal) to DC Input 1 NEG on DCFF pin 15 (return)
 - DC Input 2 POS on DCFF pin 4 (signal) to DC Input 2 NEG on DCFF pin 3 (return)
- One RS-232 Serial Interface for Maintenance
- Two ARINC 429 High Speed or Low Speed signals with Air Data and Heading labels as shown in Table 1 below.

DOCUMENT	AIS-380 DC FUEL FLOW ADAPTER	
Control SC1	INSTALLATION MANUAL	
Revision B	M833811-30	Page: 7 of 31

2.4.2 OUTPUTS

- ARINC 429 label set described in Table 1 forwarded from input
- Two ARINC 429 High Speed or Low Speed signals
 - Label 244 and 347
- One RS-232 Serial Interface with fuel flow data, reference Table 4 for serial output formats.

Table 1 below defines the ARINC 429 labels which are received at the input of the DCFF and the labels that are transmitted out.

Table 1 – ARINC 429 Data I/O

	ARINC 429 Input	ARINC 429 Output
ARINC 429 Channel 1	102, 203, 204, 205, 206, 207, 210, 211, 212, 213, 234, 235, 236, 237, 312, 314, 350, 353	102, 203, 204, 205, 206, 207, 210, 211, 212, 213, 234, 235, 236, 237, 312, 314, 350, 353, 244, 347
ARINC 429 Channel 2	320	320, 244, 347

Labels 244 and 347 are the labels generated by the DCFF and are shown in bold at the output of Channel 1 and 2. All of the data listed in the ARINC 429 Output column in Table 1 above is sent out on SERIAL 2 in RS-232 format.

Label 347 - The DCFF converts the fuel flow from gallons/hr to lbs/hr to be transmitted on label 347.

Label 347 provides fuel flow per engine by using the SDI bits to indicate which engine, and sending each engine's data in a round robin fashion. SDI bits 10,9 = 0,1 (Left), 1,0 (Right).

Transmit interval = 125 msec, for an effective transmit interval of 250 msec per engine. The data format is as follows:

Bits	1 2 3 4 5 6 7 8	9 10	11 12	13 14 15 16 17 18 19 20 21 22 23 24 25 26 27 28	29	30 31	32
	Label 347	SDI	0 0	DATA	S	SM	Parity

Data type	BNR	Equipment ID: 029	Bit 29 = 0 (Sign)
Significant bits	16		Bit 30, 31 = 1, 1 (Normal Op)
Resolution	0.5 lbs/hr (LSB value)		Bit 30, 31 = 0, 0 (Failed)
Range	32768 lbs/hr		Bit 32 ⇒ ODD Parity

Label 244 - The DCFF outputs Total Fuel Flow Rate on label 244 also in lbs/hr. Label 244 provides total fuel flow. Transmit interval = 125 msec. The data format is as follows:

Bits	1 2 3 4 5 6 7 8	9 10	11 12	13 14 15 16 17 18 19 20 21 22 23 24 25 26 27 28	29	30 31	32
	Label 244	0 0	0 0	DATA	S	SM	Parity

Data type	BNR	Equipment ID: 08D	Bit 29 = 0 (Sign)
Significant bits	16		Bit 30, 31 = 1, 1 (Normal Op)
Resolution	0.5 lbs/hr (LSB value)		Bit 30, 31 = 0, 0 (Failed)
Range	32768 lbs/hr		Bit 32 ⇒ ODD Parity

DOCUMENT	AIS-380 DC FUEL FLOW ADAPTER	
Control SC1	INSTALLATION MANUAL	
Revision B	M833811-30	Page: 8 of 31

2.4.3 AIR DATA AND HEADING CONVERSION

See Figure 2 below

Inputs: The Air Data and Heading sources provide data to the DCFF via ARINC 429 inputs. ARINC 429 Channel 1 accepts Altitude, Airspeed, and OAT ARINC 429 labels. ARINC 429 Channel 2 accepts the Mag Heading ARINC 429 label. See Table 1 above for specific ARINC 429 labels used.

Output: The DCFF transmits the data along with fuel flow data to the GPS via the RS-232 port, Channel 2. The RS-232 serial format is programmed using the Maintenance Interface. The available formats are listed in Table 4 below in Section 5.1.2

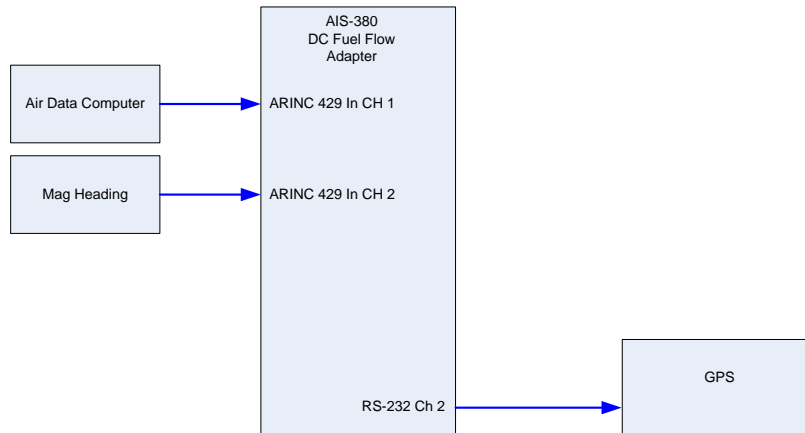



Figure 2 : Air Data Computer/Heading ARINC 429 to RS-232

DOCUMENT	AIS-380 DC FUEL FLOW ADAPTER	
Control SC1	INSTALLATION MANUAL	
Revision B	M833811-30	Page: 9 of 31

2.5 SOFTWARE CERTIFICATION

This product was developed in accordance with RTCA/DO-178B Design Assurance Level C.

2.6 REGULATORY CERTIFICATION

This product is certified for TSO-C44c INCOMPLETE SYSTEM.

2.7 RELIABILITY

MTBF (Mean Time Between Failures) Greater than 20,000 hours

Mean time between failures (MTBF) is calculated following MIL-HDBK-217F guidance as a starting point, when available field or vendor data is used in place of MIL-HDBK-217F predictions. The DCFF prediction is for an environment of airborne, inhabited, cargo. At 20°C the prediction is greater than 30,000 hours.

2.8 ACCURACY

Fuel Flow conversion based on $\pm 10\text{mV}$ of max input of 10V nominal accuracy is 0.1% of full scale.

DOCUMENT	AIS-380 DC FUEL FLOW ADAPTER	
Control SC1	INSTALLATION MANUAL	
Revision B	M833811-30	Page: 10 of 31

3 INSTALLATION

3.1 LIMITATIONS

The conditions and tests required for TSO approval of this article are minimum performance standards. It is the responsibility of those installing this article either on or within a specific type or class of aircraft to determine that the aircraft installation conditions are within the TSO standards. TSO articles must have separate approval for installation in an aircraft. The article may be installed only if performed under 14 CFR part 43 or the applicable airworthiness requirements.

This equipment is developed to Design Assurance Level (DAL C). TSO C44c lists the loss of fuel flow functionality to be Hazardous. It is the responsibility of those installing this article to determine if it meets the needs set forth in the System Safety Assessment.

3.2 INCOMPLETE SYSTEM

Shadin Avionics manufactures the DCFF as an incomplete system under TSO-C44c, *Fuel Flowmeters* and performs to the relevant performance standards of AS407C, *Fuel Flowmeters* as tested by RTCA/DO-160F, *Environmental Conditions and Test Procedures for Airborne Equipment*.

This DCFF is compatible with any flow signal whose output is a DC analog voltage in the range of 0 to +10VDC. Installation Drawing D833811-30, included in Appendix A of this manual, provides connector J1 pin out information for proper wiring.

The DCFF provides data conversion for display. The installer must substantiate the interoperability when showing compliance to the applicable airworthiness.

3.2.1 PERFORMANCE STANDARDS

The DCFF meets the performance standards of AS407C paragraph 3.3 for Environmental Conditions, 4.5 for Power Variations, as defined in section 4 of this document in the Environmental Qualification Form (EQF) for an incomplete system to the fuel flowmeter. Scale errors are within 0.5% in accordance with paragraph 6.1 of AS407C.

3.3 MOUNTING

The DCFF (P/N 833811-30) can be mounted in any orientation in the aircraft. The hardware should be mounted using four (4) number 8 size screws in a dry location. The equipment should be installed in a controlled temperature and pressurized location.

DOCUMENT	AIS-380 DC FUEL FLOW ADAPTER	
Control SC1	INSTALLATION MANUAL	
Revision B	M833811-30	Page: 11 of 31

3.4 ELECTRICAL CONNECTION

Connector and pin number, signal name, and signal description of the electrical connections for the unit are provided in this section. J1 main connector is a high density 44 pin male D-Subminiature. Mate with cabled 44 pin female D-Subminiature connector. The Installation Drawing in Appendix A provides the full list of pin functions.

Table 2: DCFF J1 Electrical Connections

Pin (Note 1)	Signal	Description	Comments
1	PWR GND	28 VDC Power Negative input	(Note 2)
2	+28V PWR	28 VDC Power Positive input	(Note 2)
3	DC-INPUT-2-NEG	Analog Input 1 return	(Note 3)
4	DC-INPUT-2-POS	Analog Input 1 signal	
5	DISCRETE-IO-1	Discrete Input	Open = Valid / Gnd = Invalid
9	DC-INPUT-1-POS	Analog Input 1 signal	
10	ARINC-429-TX1-B	ARINC 429 Output #1 (Line B)	
11	ARINC-429-TX2-B	ARINC 429 Output #2 (Line B)	
12	ARINC-429-RX2-B	ARINC 429 Input #2 (Line B)	
15	DC-INPUT-1-NEG	Analog Input 1 return	(Note 3)
16	PWR GND	28 VDC Power Negative input	(Note 2)
17	+28V PWR	28 VDC Power Positive input	(Note 2)
19	SER-1-RX	Serial 1 RS-232 Receive	RESERVED - programming
20	SER-2-TX	Serial 2 RS-232 Transmit	
25	ARINC-429-TX1-A	ARINC 429 Output #1 (Line A)	
26	ARINC-429-TX2-A	ARINC 429 Output #2 (Line A)	
27	ARINC-429-RX2-A	ARINC 429 Input #2 (Line A)	
34	SER-1-TX	Serial 1 RS-232 Transmit	RESERVED - programming
37	CHASSIS-GND	Chassis Ground	
40	ARINC-429-RX1-A	ARINC 429 Input #1 (Line A)	
41	ARINC-429-RX1-B	ARINC 429 Input #1 (Line B)	

Note 1: Pin numbers not shown are not used

Note 2: Two pins for 28V-IN and POWER-GND-IN are internally connected but not diode isolated - only one of each is required

Note 3: If the fuel flow signal source does not have two wire output, this pin should be grounded.

DOCUMENT	AIS-380 DC FUEL FLOW ADAPTER	
Control SC1	INSTALLATION MANUAL	
Revision B	M833811-30	Page: 12 of 31

3.4.1 TYPICAL INSTALLATION WIRING

Standard installation is shown below in Figure 3.

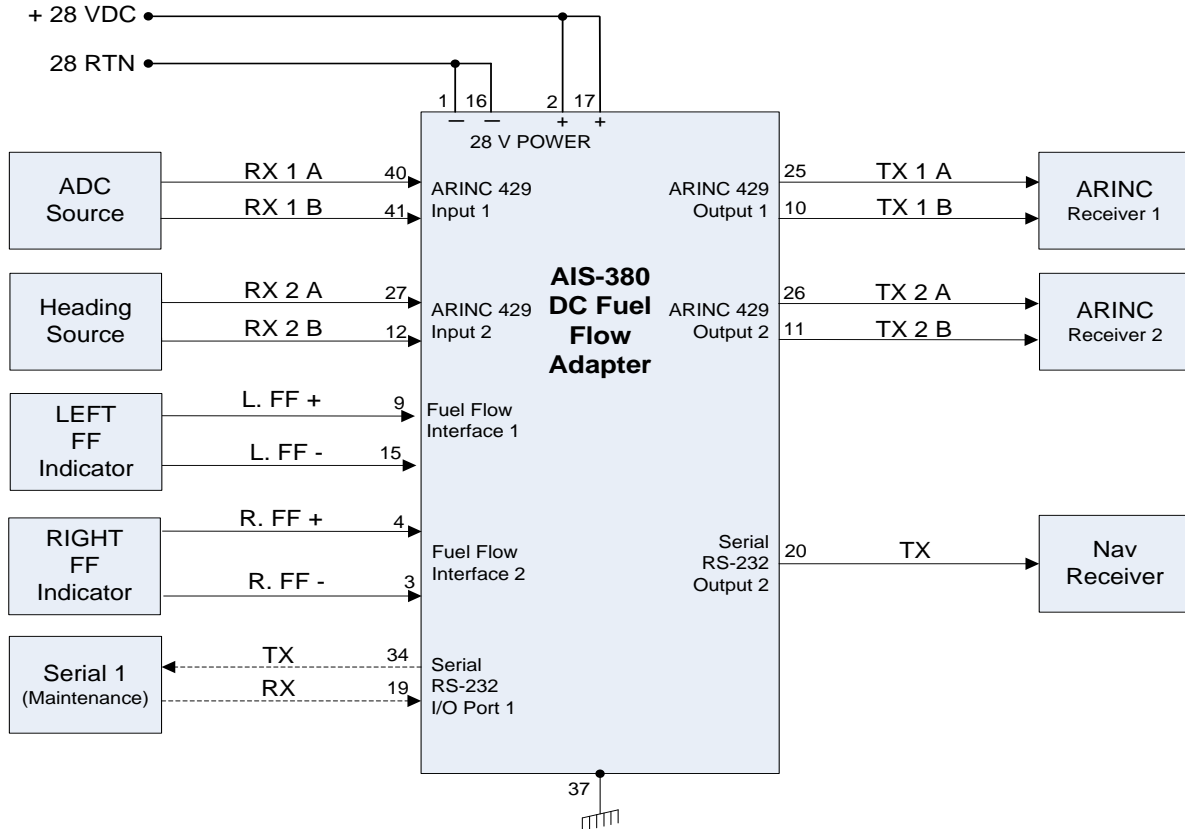



Figure 3 : Standard DC Fuel Flow Configuration

Aircraft power +28 VDC can be connected to both pins 2 and 17 for redundancy as shown in Figure 3. Alternatively, the unit can be powered only through pin 2, or only through pin 17. The same applies to the return lines: Pins 1 and 16 can both be routed to the aircraft 28 V return, or return can be connected to either pin 1 or pin 16.

Pin 37 is tied directly to the DCFF chassis. After the DCFF is mounted to the airframe, this pin is equivalent to airframe ground and can be used as a connection to cable shields in the connector backshell.

DOCUMENT	AIS-380 DC FUEL FLOW ADAPTER	
Control SC1	INSTALLATION MANUAL	
Revision B	M833811-30	Page: 13 of 31

The AIS-380 DC Fuel Flow K-Factors and Offsets for specific aircraft/indicators are listed below in Table 3. If a specific aircraft/indicator is not listed, contact Shadin Avionics technical support at (952) 836-2269.

Table 3 – AIS-380 DC Fuel Flow K-Factors

Indicator P/N	K-factor (ppg)	Offset (Hz)
Beech King Air		
90-380009-2	49,050	24
90-380009-5	49,050	24
101-384009-1	49,050	24
101-384153-1,3	19,647	0
PC900-6A0600-XXX	24,599	0
PC900-1A0750-XXX	19,679	0
PC900-1A0800-XXX	18,449	0
Beechjet 400A		
PC900-3B2000-PH-1	7,400	0
Piper Cheyenne		
3265013-0601	29,470	0
3260513-1201	29,470	0
Cessna Citation		
393002-009	9,400	0
9912049-2	9,400	0
9912147-16	10,400	0
VSDL-OC208E	10,400	0
9912560-5	14,020	0
Israeli Aircraft Ind. Westwind		
1291-2	6,700	0

3.4.2 VOLTAGE TO FUEL FLOW K FACTOR

K Factor can be calculated with this equation.

$$\text{K-factor} = 439,453.123 * \text{Volts} / (\text{Fuel Flow in GPH})$$

3.5 REPAIR

Units needing repair or that have failed should be returned to Shadin Avionics. Contact technical support for assistance by phone at (952) 927-6500 or (800) 388-2849, or email at service@shadin.com

DOCUMENT	AIS-380 DC FUEL FLOW ADAPTER	
Control SC1	INSTALLATION MANUAL	
Revision B	M833811-30	Page: 14 of 31

4 ENVIRONMENTAL QUALIFICATION FORM (EQF)

The Shadin Qualification Testing Report (QTR), SD-170073, provides details of the qualification of the DCFF. The DCFF is similar to the 833811-00/833811-01/833812-10/833820 products, with the addition of a mezzanine CCA accepting analog inputs on formerly unused pins. The QTR addresses the similarity of the DCFF to the previously qualified products for environments which are equivalent between DO-160G and DO-160F. In areas where the addition of the new analog mezzanine CCA could have an impact, a retest to the DO-160G levels was performed.

NOMENCATURE: AIS-380 DC Fuel Flow Adapter

TYPE/MODEL/PART NO: 833811-30 **TSO NUMBER:** **CERTIFICATION:** TSO-C44c INCOMPLETE SYSTEM

SPECIFICATION: RTCA/DO-160F, SD-110037 and SD-170073

MANUFATURER: Shadin Avionics **ADDRESS:** 6831 Oxford Street, St. Louis Park, Minnesota 55426

<u>CONDITIONS</u>	<u>SECTION</u>	<u>DESCRIPTION OF TESTS CONDUCTED</u>
Temperature and Altitude	4.0	A4X
Low Temperature (Operating)	4.5.1	-40°C [See remarks (1)]
High Temperature (Operating)	4.5.2, 4.5.3	+70°C
Altitude	4.6.1	42,000ft [See remarks (2)]
Decompression	4.6.2	42,000ft [See remarks (2)]
Overpressure	4.6.3	-15,000ft
Temperature Variation	5.0	Tested to Category B
Humidity	6.0	Tested to Category B
Operational Shock and Crash Safety	7.0	Tested to Category B
Vibration	8.0	Tested to Category R(B,B1)U2(F,F1)
Explosion	9.0	Qual by Similarity to Category E [See remarks (3)]
Waterproofness	10.0	Identified as Category X. Not tested
Fluids Susceptibility	11.0	Identified as Category X. Not tested
Sand and Dust	12.0	Identified as Category X. Not tested
Fungus	13.0	Identified as Category X. Not tested
Salt Spray	14.0	Identified as Category X. Not tested
Magnetic Effect	15.0	Tested to Category Z
Power Input	16.0	Tested to Category BXX
Voltage Spike	17.0	Tested to Category A
Audio Frequency Susceptibility	18.0	Tested to Category Z
Induced Signal Susceptibility	19.0	Tested to Category CC
Radio Frequency Susceptibility	20.0	Tested to Category RR
Radio Frequency Emission	21.0	Tested to Category M
Lightning Induced Transient Susceptibility	22.0	Tested to Category XXJ3L3
Lightning Direct Effects	23.0	Identified as Category X. Not tested
Icing	24.0	Identified as Category X. Not tested
Electrostatic Discharge	25.0	Tested to Category A.
Fire, Flammability	26.0	Identified as Category X. Not tested

REMARKS:

- (1) The 833811-00 was tested to -40°C, beyond the normal A4 category temperature limits.
- (2) The 833811-00 was tested to +42,000 ft., beyond the normal A4 category altitude and decompression limits.
- (3) The 833812-10 was tested in Explosive Atmosphere Category E and passed.

DOCUMENT	AIS-380 DC FUEL FLOW ADAPTER	
Control SC1	INSTALLATION MANUAL	
Revision B	M833811-30	Page: 15 of 31

5 CONFIGURATION TOOL

This section describes the use of the 833811-30 Fuel Flow Configuration Tool. The DCFF is to be configured on a test bench using the configuration tool prior to installation in the aircraft. Below is a list of the equipment needed and the instructions for installing and configuring the DCFF with the configuration tool.

Equipment List

- +18 V to +28 V DC Power Supply
- CK833811-30 Configuration Kit for 833811-30*
- Desktop or Laptop PC with serial port or USB adapter if no serial port is available

Installation Requirements for PC

- Windows XP SP3 or Windows 7/8/10
- 1 MB hard disk space
- Intel® Pentium® Processor, 1.6 GHz minimum
- 500 MB RAM minimum

* Contact Shadin Tech Support to obtain CK833811-30:

Web: www.shadin.com
E-mail: service@shadin.com
Phone: (952) 927-6500 or
(800) 388-2849

The software and the cable required for this tool are included in the kit. Alternatively, a cable configured per Figure 4 below can be built to interface the DCFF to the PC. The software can be acquired separately from Shadin Tech Support.

DOCUMENT	AIS-380 DC FUEL FLOW ADAPTER	
Control SC1	INSTALLATION MANUAL	
Revision B	M833811-30	Page: 16 of 31

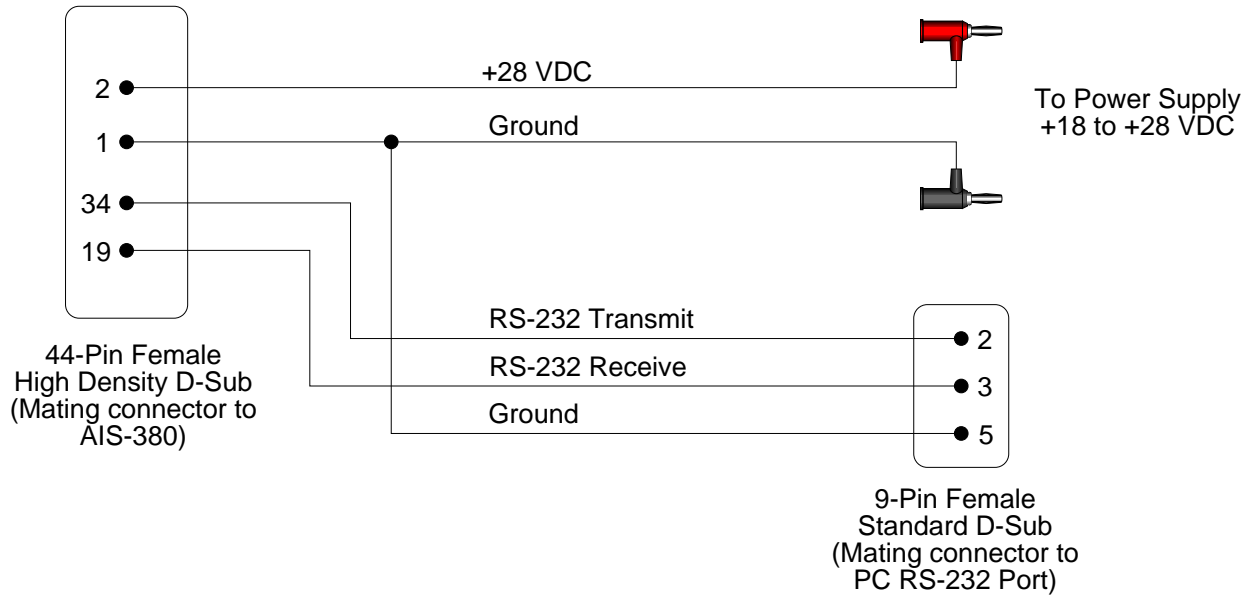

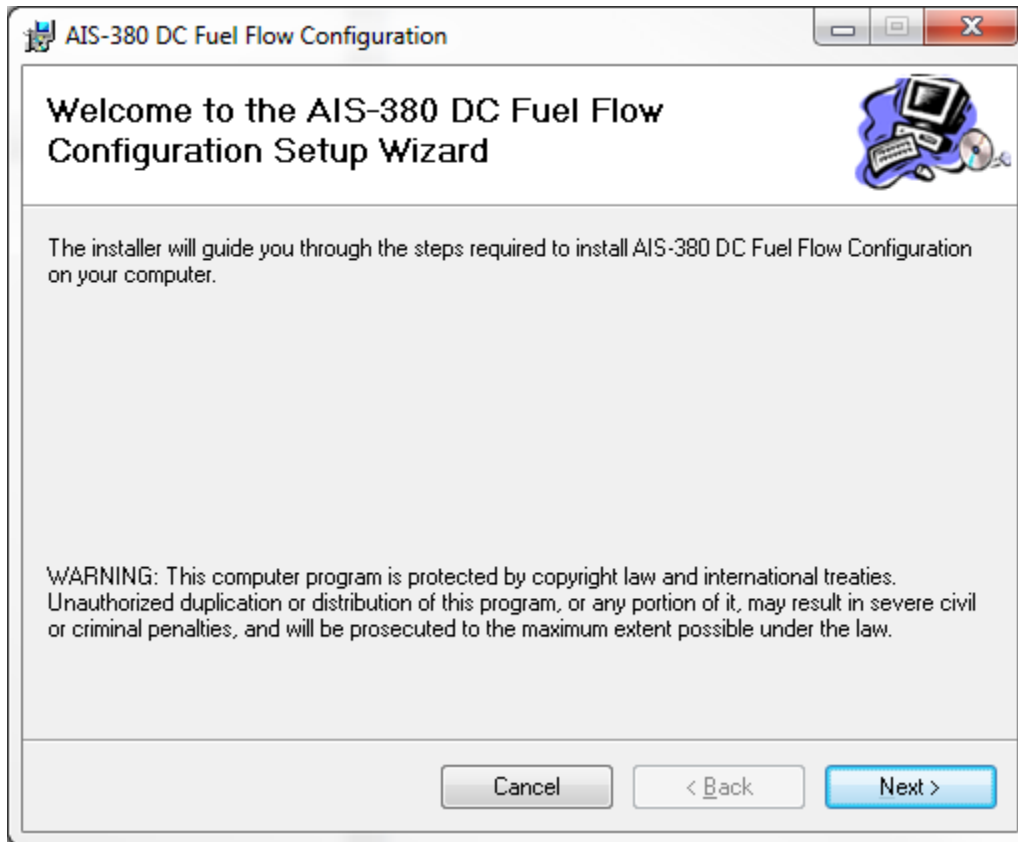

Figure 4 : Field Configuration Cable

5.1.1 CONFIGURATION TOOL SOFTWARE INSTALLATION

- (1) Copy 463803.msi and setup.exe to a local folder on the PC.
- (2) Run setup.exe. The following dialog box will appear:

DOCUMENT	AIS-380 DC FUEL FLOW ADAPTER	
Control SC1	INSTALLATION MANUAL	
Revision B	M833811-30	Page: 17 of 31



(3) Follow the Setup Wizard instructions.

(4) Click Next

DOCUMENT	AIS-380 DC FUEL FLOW ADAPTER	
Control SC1	INSTALLATION MANUAL	
Revision B	M833811-30	Page: 18 of 31

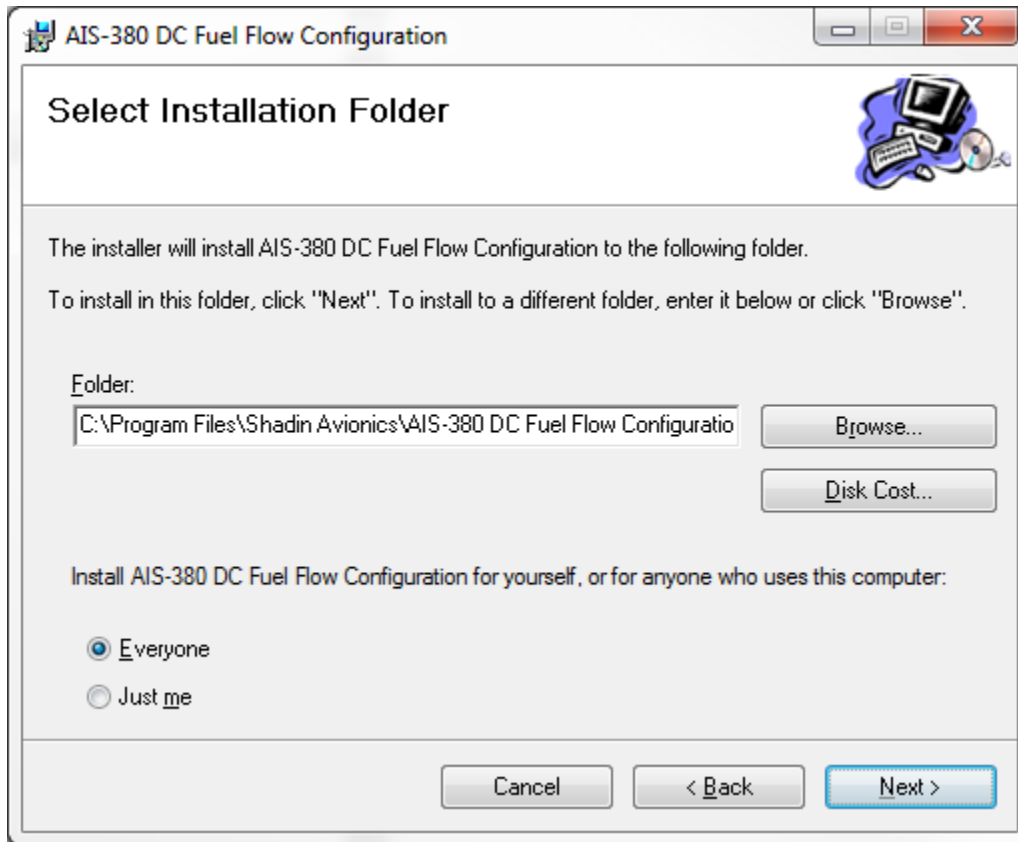

(5) Choose install location and user access to tool (Default settings are shown in the picture above) and click on Next.

(6) A Confirm Installation window will appear as shown below, click Next.

DOCUMENT	AIS-380 DC FUEL FLOW ADAPTER	
Control SC1	INSTALLATION MANUAL	
Revision B	M833811-30	Page: 19 of 31

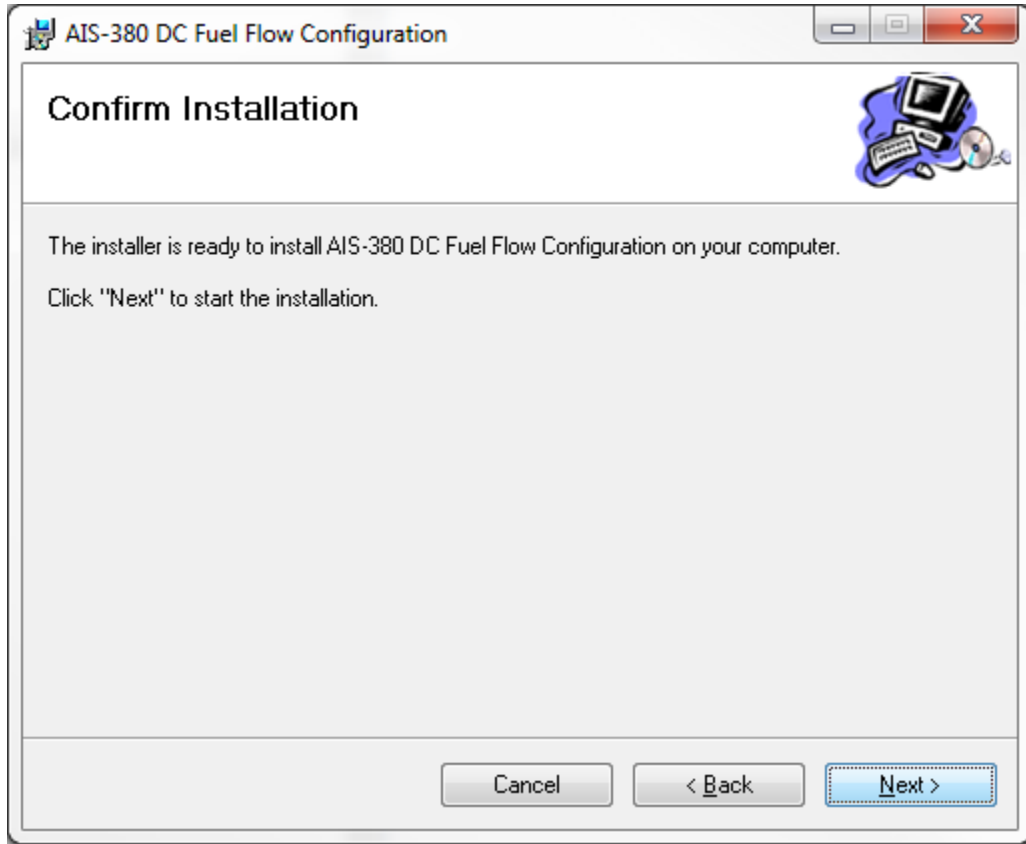

(7) A progress bar will appear as seen below, it may take a few moments for progress to be evident, please be patient.

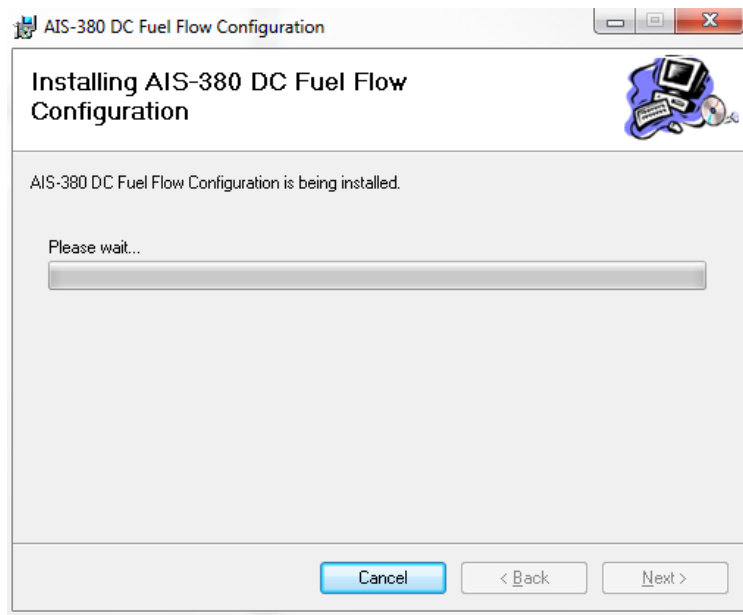

DOCUMENT	AIS-380 DC FUEL FLOW ADAPTER	
Control SC1	INSTALLATION MANUAL	
Revision B	M833811-30	Page: 20 of 31

(8) After installation, confirm the following message is displayed:

“AIS-380 DC Fuel Flow Configuration has been successfully installed.”

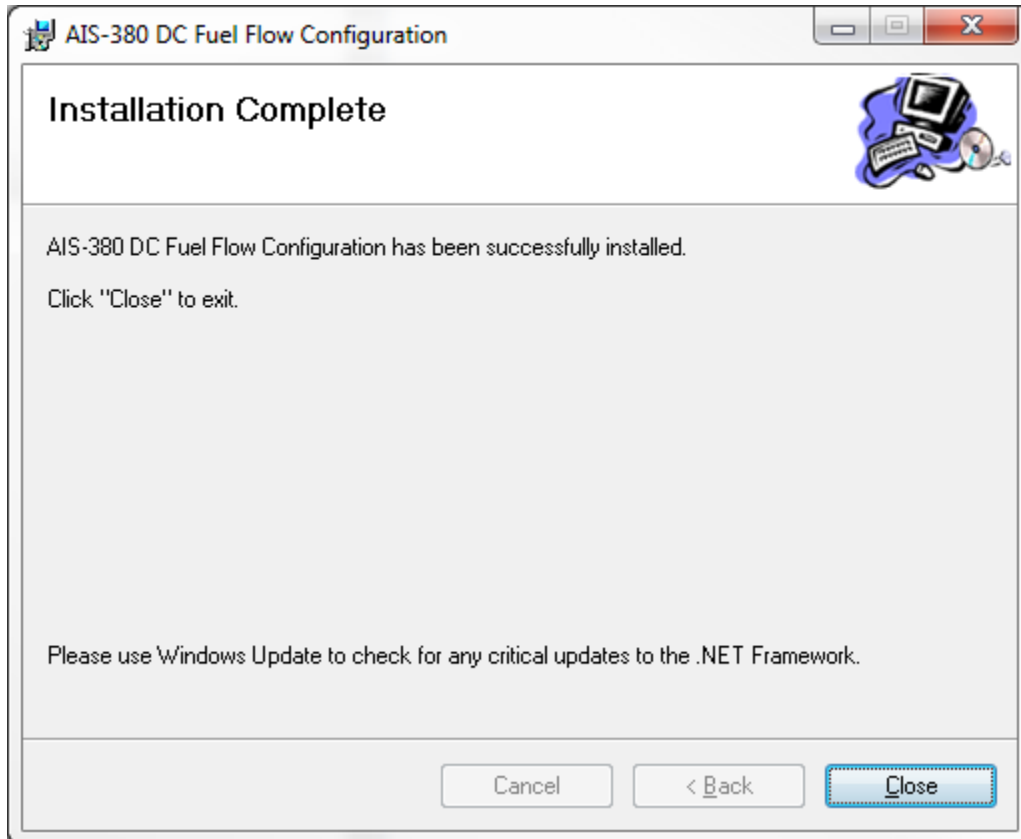



(9) Close the 833811-30 Fuel Flow Configuration Wizard dialog box.

DOCUMENT	AIS-380 DC FUEL FLOW ADAPTER	
Control SC1	INSTALLATION MANUAL	
Revision B	M833811-30	Page: 21 of 31

5.1.2 USING THE CONFIGURATION TOOL

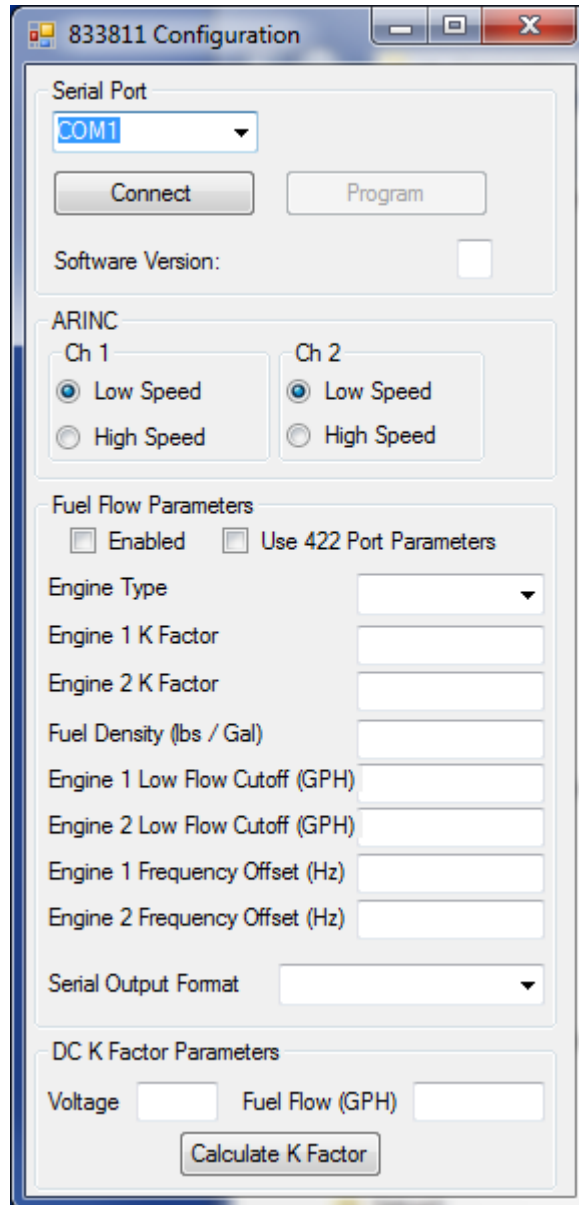
- (1) Connect the PC to the DCFF using the Field Configuration Cable.
- (2) Apply +28 VDC to the power leads of the Configuration cable which is connected to the DCFF.
- (3) On the PC, navigate to the location of the 833811-30 Fuel Flow Configuration Tool icon which points to the newly installed program 463803-02.exe. Double-click the icon to start up the program. The following dialog box will appear:



DOCUMENT	AIS-380 DC FUEL FLOW ADAPTER	
Control SC1	INSTALLATION MANUAL	
Revision B	M833811-30	Page: 22 of 31

(4) Select the appropriate COM Serial Port which is connected to the DCFF and press the Connect button.

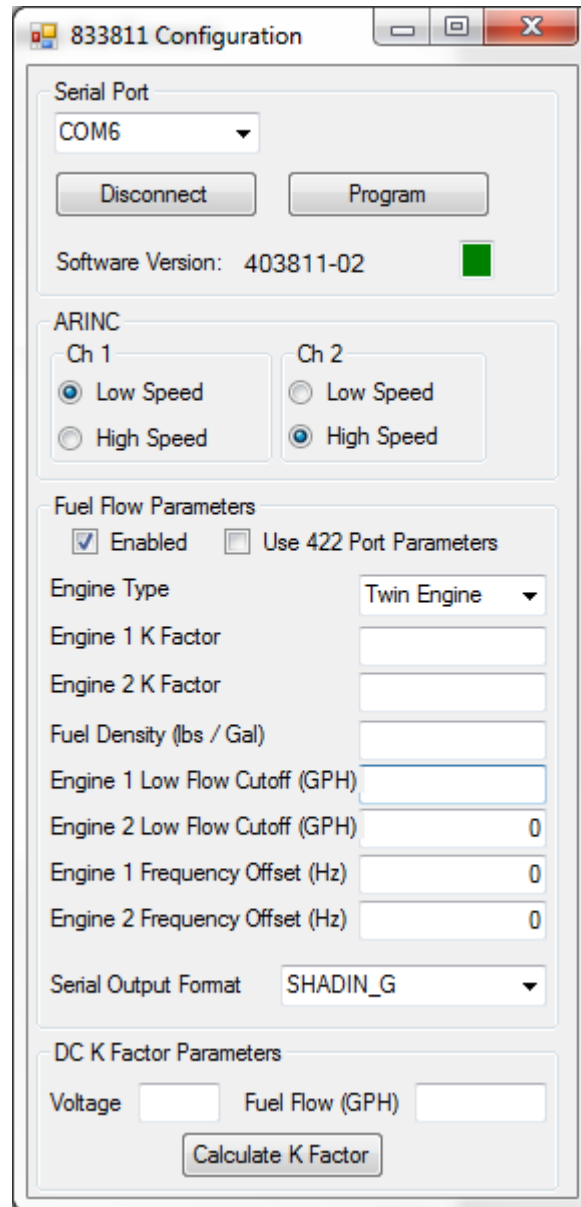

(5) Wait for the Software Version number to appear, and the status indicator located next to the software version number to turn from yellow to green. If the indicator remains yellow, check the serial port cable connections and re-run the program.

DOCUMENT	AIS-380 DC FUEL FLOW ADAPTER	
Control SC1	INSTALLATION MANUAL	
Revision B	M833811-30	Page: 23 of 31

Below is an example of the result of a disconnected serial cable. Note the box next to Software Version remains yellow in color:

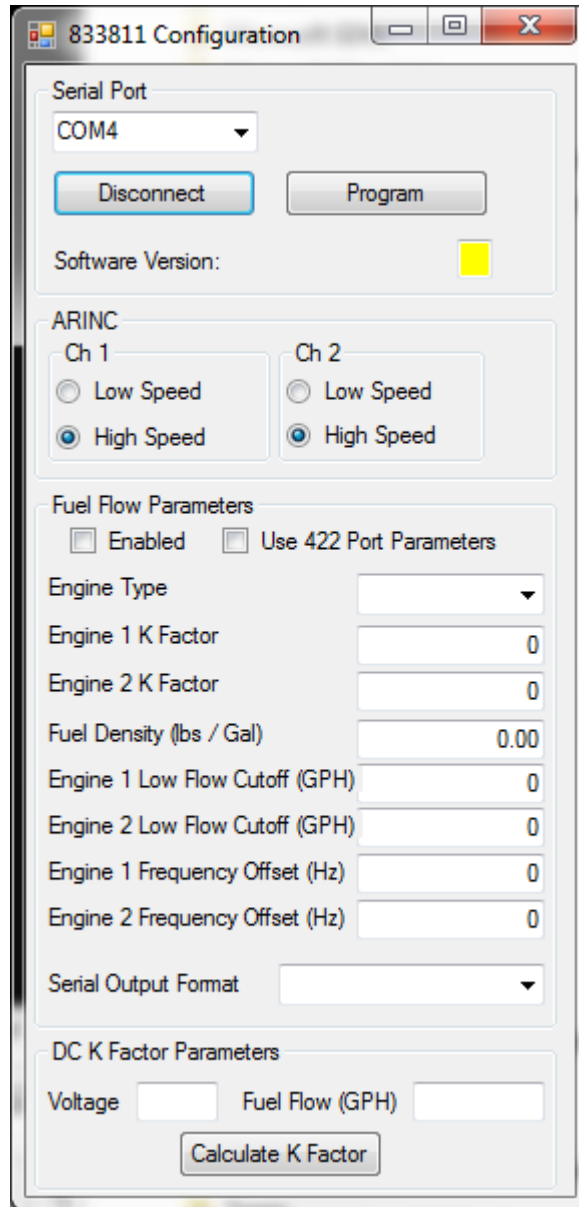

- (6) Select the desired speed for each ARINC channel.
- (7) Under Fuel Flow Parameters, select Enabled.
- (8) Set Use 422 Port Parameters box to unchecked.
- (9) Select the appropriate Engine Type from the drop-down list: Single Engine or Twin Engine.

DOCUMENT	AIS-380 DC FUEL FLOW ADAPTER	
Control SC1	INSTALLATION MANUAL	
Revision B	M833811-30	Page: 24 of 31

(10) Enter a DC voltage and Fuel Flow at that voltage in the lower section of this tool. Click on “Calculate K Factor” and the K factor will be calculated and populated above. If K factor is known, enter K factor for Engine 1 and/or Engine 2.

(11) Enter a Fuel Density number between 0.00 and 10.00. Fuel Density examples are 5.80 for AvGas and 6.71 for Jet A.

(12) Select the applicable Serial Output Format based on the equipment that will be connected to SERIAL 2 in the planned aircraft installation. The serial output formats available are given in Table 4 below:

Table 4 – Serial Output Formats

SHADIN_Z
SHADIN_G
BENDIX_D_GPH
BENDIX_D_PPH
BENDIX_D_LPH
CHELTON
GENERIC_FF_GPH
GENERIC_FF_LPH
GENERIC_FF_PPH



DOCUMENT	AIS-380 DC FUEL FLOW ADAPTER	
Control SC1	INSTALLATION MANUAL	
Revision B	M833811-30	Page: 25 of 31

Figure 5 Selecting Serial Output Formats

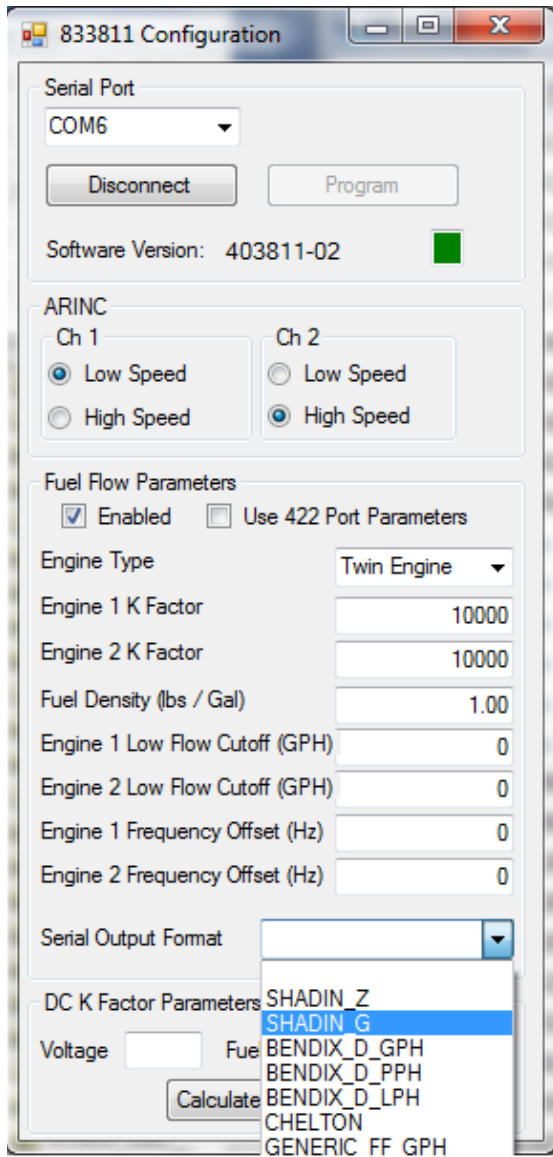

(13) Press the Program button. Wait for the status indicator to turn from yellow to green. The DCFF configuration is now set.

DOCUMENT	AIS-380 DC FUEL FLOW ADAPTER	
Control SC1	INSTALLATION MANUAL	
Revision B	M833811-30	Page: 26 of 31

See the example below for a configuration with all fields completed:

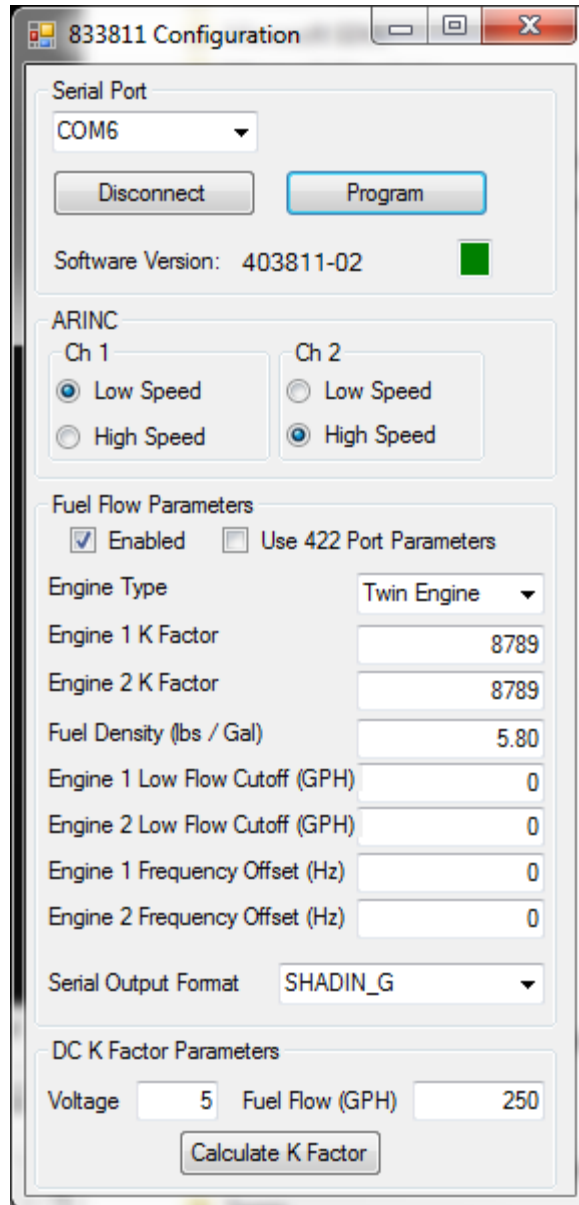

(14) Turn power OFF to the DCFF and disconnect the configuration cable. The DCFF is now ready for aircraft installation.

DOCUMENT	AIS-380 DC FUEL FLOW ADAPTER	
Control SC1	INSTALLATION MANUAL	
Revision B	M833811-30	Page: 27 of 31

APPENDIX A: INSTALLATION DRAWING

Installation drawing D833811-30 is provided on the next page.

REVISIONS					
ERN #	REV.	DATE	BY	APP'D	DESCRIPTION
1804/003	-	4/6/2018	EG	MET	BASELINE RELEASE

4 J1 CONNECTOR PIN OUT									
PIN	SIGNAL NAME	DESCRIPTION	TYPE(REF)	PAIR(REF)	PIN	SIGNAL NAME	DESCRIPTION	TYPE(REF)	PAIR(REF)
1	PWR GND	POWER RETURN	SINGLE	N/A	23	DISCRETE-IO-4	DISCRETE INPUT/OUTPUT #4	SINGLE	N/A
2	+28V PWR	28 VDC POWER POSITIVE	SINGLE	N/A	24	RESERVED			PIN 14, 28
3	DC-INPUT-2-NEG	ANALOG INPUT #2 RETURN	STP	PIN 4	25	ARINC-429-TX1-A	ARINC 429 OUTPUT #1 (LINE A)	STP	PIN 10
4	DC-INPUT-2-POS	ANALOG INPUT #2 SIGNAL	STP	PIN 3	26	ARINC-429-TX2-A	ARINC 429 OUTPUT #2 (LINE A)	STP	PIN 11
5	DISCRETE-IO-1	DISCRETE INPUT/OUTPUT #1	SINGLE	N/A	27	ARINC-429-RX2-A	ARINC 429 INPUT #2 (LINE A)	STP	PIN 12
6	DISCRETE-IO-3	DISCRETE INPUT/OUTPUT #3	SINGLE	N/A	28	RESERVED			N/A
7	SER-3-RX	SERIAL 3 RECEIVE POSITIVE	STP	PIN 8	29	DISCRETE-OUT-5	DISCRETE OUTPUT #5	SINGLE	N/A
8	SER-3-RX-NEG	SERIAL 3 RECEIVE NEGATIVE	STP	PIN 7	30	+5V-PWR-RTN	EXTERNAL DISPLAY SUPPLY RETURN	SINGLE	PIN 3, 4, 44
9	DC-INPUT-1-POS	ANALOG INPUT #1 SIGNAL	STP	PIN 15	31	SER-3-TX	SERIAL 3 TRANSMIT POSITIVE	STP	PIN 32
10	ARINC-429-TX1-B	ARINC 429 OUTPUT #1 (LINE B)	STP	PIN 25	32	SER-3-TX-NEG	SERIAL 3 TRANSMIT NEGATIVE	STP	PIN 31
11	ARINC-429-TX2-B	ARINC 429 OUTPUT #2 (LINE B)	STP	PIN 26	33	SER-4-TX	SERIAL 4 TRANSMIT POSITIVE	STP	PIN 18
12	ARINC-429-RX2-B	ARINC 429 INPUT #2 (LINE B)	STP	PIN 27	34	SER-1-TX	SERIAL 1 TRANSMIT	STP	PIN 19
13	RESERVED			N/A	35	SER-4-RX	SERIAL 4 RECEIVE POSITIVE	STP	PIN 36
14	RESERVED			N/A	36	SER-4-RX-NEG	SERIAL 4 RECEIVE NEGATIVE	STP	PIN 35
15	DC-INPUT-1-NEG	ANALOG INPUT #1 RETURN	STP	PIN 9	37	CHASSIS-GND	CHASSIS GROUND	SINGLE	N/A
16	PWR GND	POWER RETURN	SINGLE	N/A	38	DOWNLOAD-ENABLE	DOWNLOAD ENABLE INPUT (ACTIVE LOW)	SINGLE	N/A
17	+28V PWR	28 VDC POWER POSITIVE	SINGLE	N/A	39	RESERVED			N/A
18	SER-4-TX-NEG	SERIAL 4 TRANSMIT NEGATIVE	STP	PIN 33	40	ARINC-429-RX1-A	ARINC 429 INPUT #1 (LINE A)	STP	PIN 41
19	SER-1-RX	SERIAL 1 RECEIVE	STP	PIN 34	41	ARINC-429-RX1-B	ARINC 429 INPUT #1 (LINE B)	STP	PIN 40
20	SER-2-TX	SERIAL 2 TRANSMIT	STP	PIN 21	42	RESERVED			N/A
21	SER-2-RX	SERIAL 2 RECEIVE	STP	PIN 20	43	DISCRETE-OUT-6	DISCRETE OUTPUT #6	SINGLE	N/A
22	DISCRETE-IO-2	DISCRETE INPUT/OUTPUT #2	SINGLE	N/A	44	+5V-PWR	EXTERNAL DISPLAY SUPPLY VOLTAGE	SINGLE	N/A

NOTES:

- ALL DIMENSIONS ARE FOR REFERENCE ONLY.
- MOUNTING SCREW SIZE: NO. 8
- WEIGHT: 0.7 LBS
- CONNECTOR J1 IS A 44 PIN HIGH DENSITY D-SUB, MALE. WIRE TYPE "SINGLE" IS A SINGLE WIRE. WIRE TYPE "STP" IS A SHIELDED TWISTED PAIR.
- MATING CONNECTOR IS A HIGH DENSITY 44 PIN FEMALE D-SUB. STP AND STT WIRE SHIELDS SHOULD BE TIED TO MATING CONNECTOR SHELL.

UNLESS OTHERWISE SPECIFIED: DRAWN PER ASME Y14.5M-2009 DIMENSIONS ARE IN INCHES	
THIRD ANGLE PROJECTION	TOLERANCES: X/X±1/64 X*±1° X.X±0.1 X.XX±0.01 X.XXX±0.005
FINISH	N/A
MATERIAL	N/A

		
ST. LOUIS PARK, MN 55426		
DRAWN	EG	4/5/2018
CHECKED	TH	4/6/2018
ENG APPR.	MET	4/6/2018
SIZE	CAGE CODE: 0Z5P5	
B	F/N D833811-30.SLDDRW	
	SCALE: N/A	SHEET 1 OF 2

<h1>INSTALLATION DWG, AIS 833811-30</h1>	
DWG. NO.	<h2>D833811-30</h2>
REV	-

M833811-30	833811-30
NEXT ASSEMBLY	USED ON
WHERE USED	

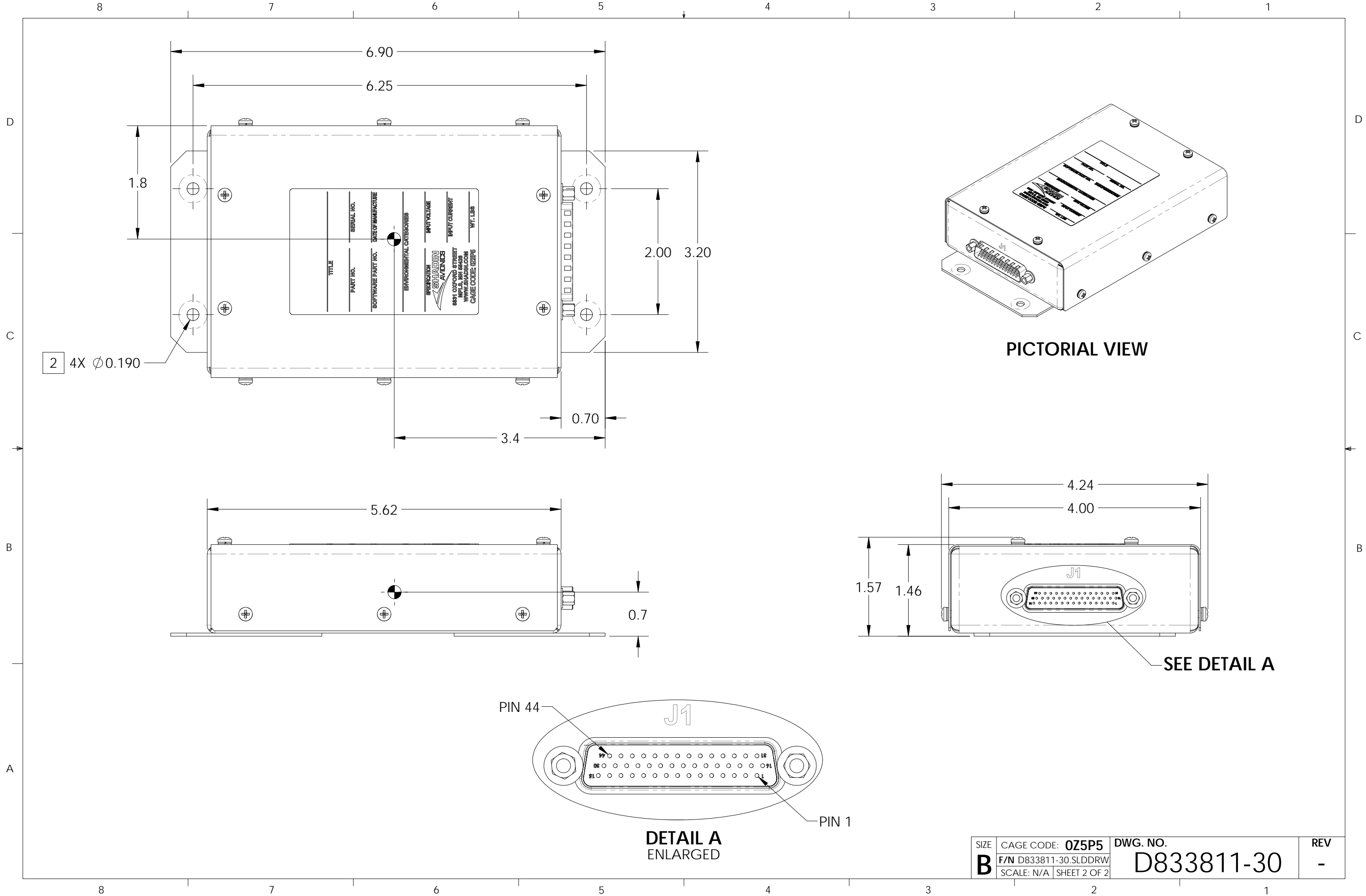

SIZE	CAGE CODE: 0Z5P5	DWG. NO.	REV
B	F/N D833811-30.SLDDRW	D833811-30	-
	SCALE: N/A	SHEET 2 OF 2	

DOCUMENT	AIS-380 DC FUEL FLOW ADAPTER	
Control SC1	INSTALLATION MANUAL	
Revision B	M833811-30	Page: 30 of 31

APPENDIX B: INSTALL KIT, PARTS LIST

The install kit parts list K833811-00 (sold separately) is provided on the next page.

Rev: -

PARTS LIST

Part #: **K833811-00**

Drawing #: NA

Description: **INSTALL KIT, AIS 833811-00**

<u>FN</u>	<u>P/N</u>	<u>QTY.</u>	<u>DESCRIPTION</u>	<u>MFG.</u>	<u>MFG.#</u>	<u>DESIGNATION</u>	<u>COMMENTS</u>
5	232012	1	CONN, HD D-Sub 44 Pin, Female Crimp w/FC8022D2 Contacts	POS	ODD44S1000X		
10	232507	1	CONN, Backshell, 25P D-Sub, Zinc Die Cast	APH	17E-1657-25		
15	239004	1	TOOL, INSERT/EXTRACT M81969/1-04	NWK	59K0052		
20	753217	1	Thermal Label, 4"x 1"	ULI	S-8601		
25	PK1001	2	BAG, 2.5 x 3, 4 MIL Zip Lock				
30	PK1007	1	BAG, 6 x 8, 4 MIL				

7 items